



Note: The product images shown may change over time as products are updated.

Part Number

WCN1-1202U-BUL3-PTFE-100C

Features

Inductive Proximity Sensors are used in a wide variety of manufacturing operations where a metal target needs to be sensed. HTM Sensors inductive proximity sensors have a Lifetime Warranty, a CSA or UL approval, and a huge inventory for same-day shipping. For tougher applications where the sensors need more range to stay out of harm's way, or to withstand high temperatures, weld spatter, chemical exposure, oil or other rough environments, HTM Sensors has the widest range of proximity sensors on the market.

Connection

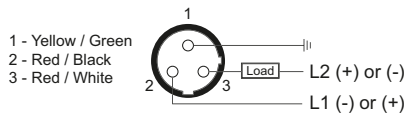

Dimensions

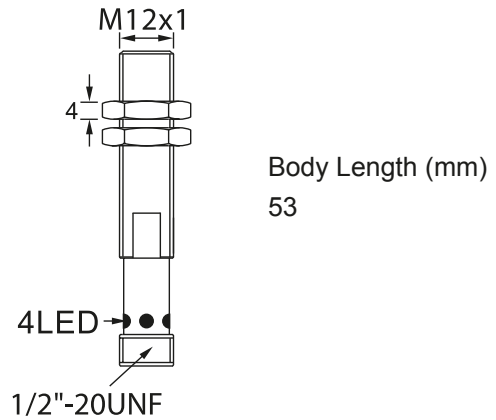

Technical Data

Body Style	Cylindrical
Sensor Housing Material	SpatterGuard™ coated Brass
Sensor Face Material	PBT Plastic
Mounting Style	Shielded
Diameter	12 mm Threaded
Sensing Range:	2 mm Range
Output Type:	AC/DC Output
Output Function	Normally Closed Output
Connection	3-Pin Connector
Connector Type	Micro Quick-Connect
Operating Voltage	20-250 VAC, 50-60HZ; 20-250 VDC
Switching Frequency	25 Hz AC; 40 Hz DC
Operating Temperature	-20 °C - +100 °C
Current Consumption	<2.5mA
IP Rating:	IP67
EMC Rating	RFI>3V/m / EFT>1kV / ESD>4Kv (contact)
Shock Rating:	IEC 60497-5-2 Part 7.4.1&7.4.2
Short Circuit Protected	Yes
Reverse Polarity Protected	NO
Max Current	200 mA
Leakage Current	<2.5mA
Surge Current	2.2 A for 20 ms
Response Time	10 ms/10 ms
Hysteresis	<15%(Sr)
Overload Trip Point	-
Weld Field Immune	Yes
Weld Spatter Resistant	Yes - SpatterGuard™ Coated
Body Length (mm)	53