

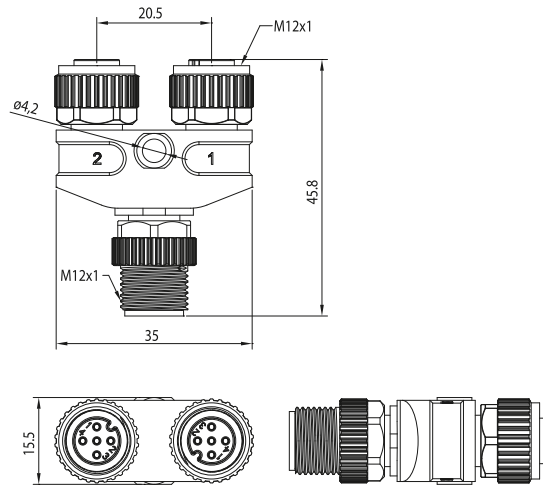

Note: The product images shown may change over time as products are updated.

Dimensions



Part Number

T2-R5/4Z-R5

Features

- TPU Coating
- A-coded Interface

Technical Data

Cable Type	T-Splitter
Connector	M12 Male Straight to 2 x M12 Female Straight
Length (m)	45.8 mm
Locking System	Screw
Rated Current	4 A
Rated Voltage	60 V AC / DC
Contact Carrier	TPU
Molded Body	TPU
Contact Material	CuSn (Bronze)
Coupling Nut	Nickel Plated Zinc
Protection Class	IP67
Temperature Range	-25 C to +90 C

Connection

Female

Female

